

## Sink Quadra R12

Kitchen Sinks

Code: 1737 050



### DETAILS

Material AISI 304 stainless steel

---

Texture Brushed in line

---

Finish Foster brushed

---

Edge/Installation Type Flush-mount | Top-mount

---

Base 80 cm

---

Dimensions 780 x 520 mm

---

Bowl dimension 740 x 430 mm

---

Width 78 cm

---

Built-in hole [View technical data sheet](#)

---

Number of bowls	1 bowl
Standard fittings	Fixing hooks, gasket, drain, overflow and siphon, boxed packing
Drainer	No
Mixer holes	2 standard holes - 3rd and 4th holes on request
Waste fitting	Drain SPACE 3,5"

## FEATURES

Deep bowls	This bowls reach an important depth, over 20 cm, thanks to the advanced production technology, that can be offer great capiciency and practicity in all the washing operations.
Diamond-shape bottom	The draining of water is an important feature in a sink, and it's always taken good care of in Foster products. In the bent-welded sinks, which would have a flat bottom, the proper draining is guaranteed by the elegant beveling, which helps the water flow.
High thickness	1mm thick steel. A significant thickness, which guarantees the maximum sturdiness and durability.
Perimetral overflow	The overflow is always a security on the Foster sinks that prevents the overflow of water in case of oversights. The perimeter drain solution improves aesthetics thanks to its square and essential shape.
Small radius	Bowls with squared shapes with a modern design and an increased capacity, for a minimal aesthetics connected with an extreme practicity.

## TECHNICAL DATA

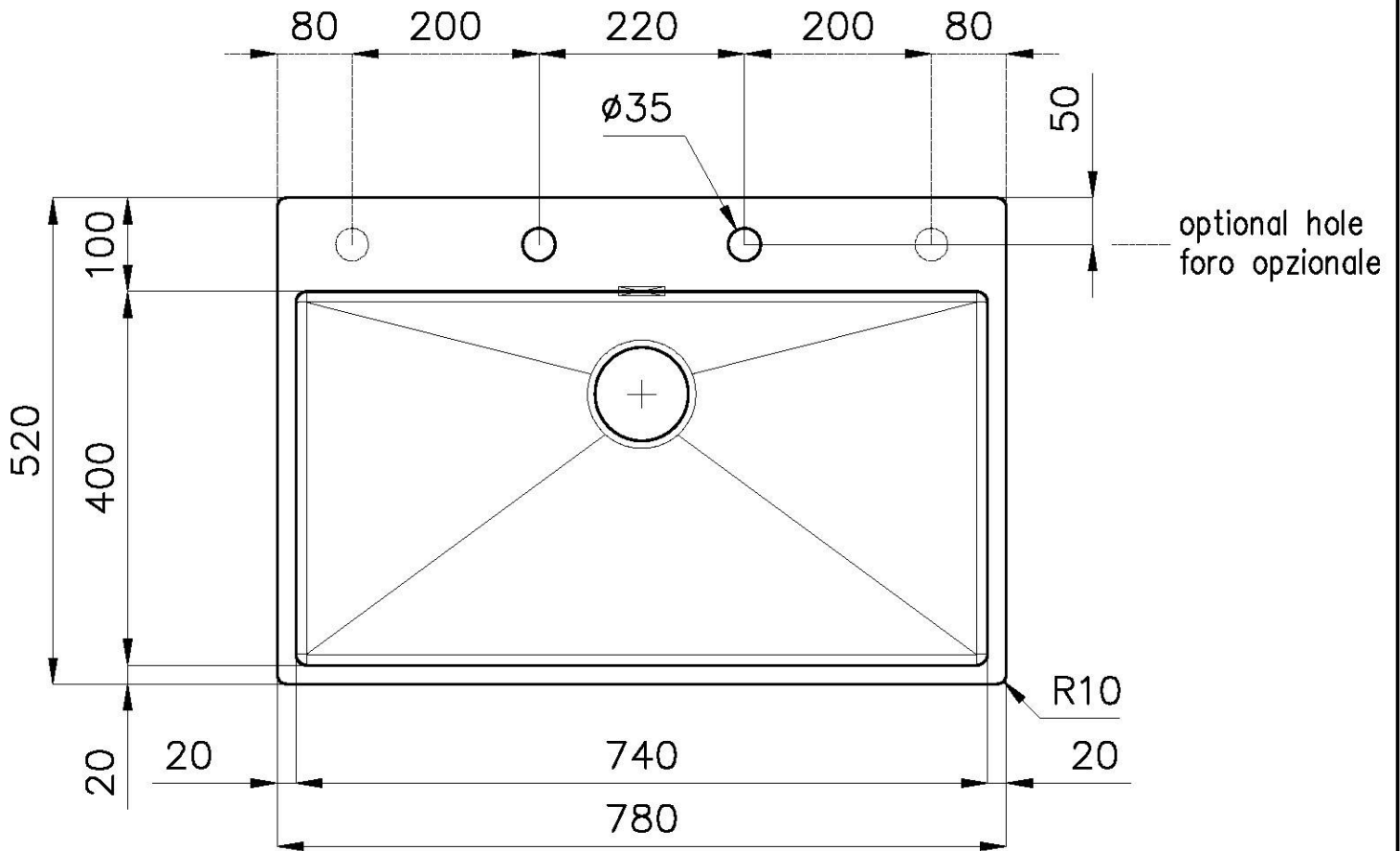
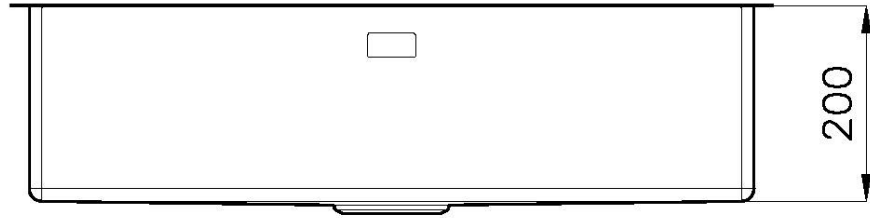

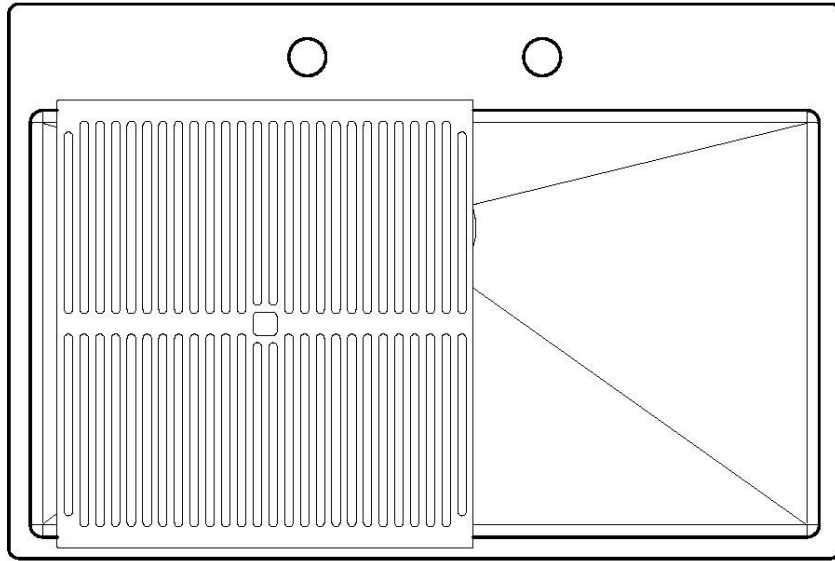

8100 617  
POSIZIONATA A FILO VASCA / EDGE POSITIONING

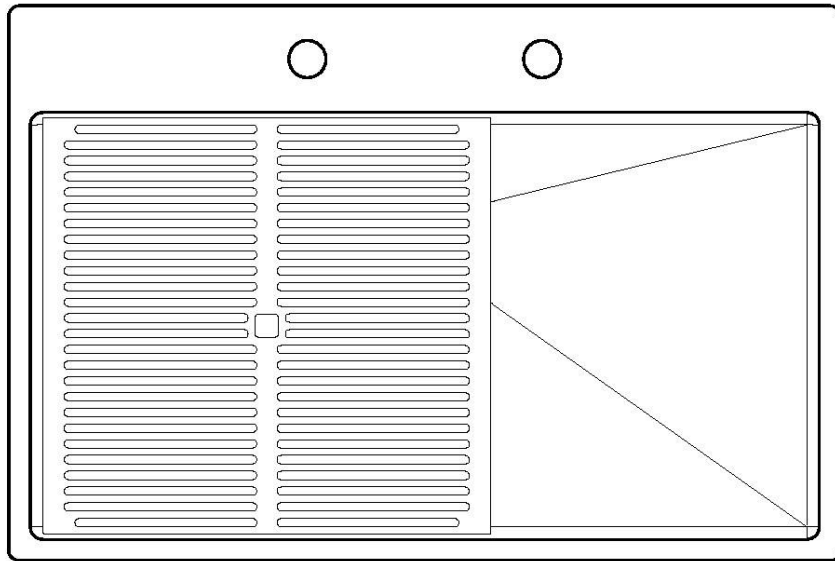

8100 617  
POSIZIONATA SUL FONDO / BOTTOM POSITIONING

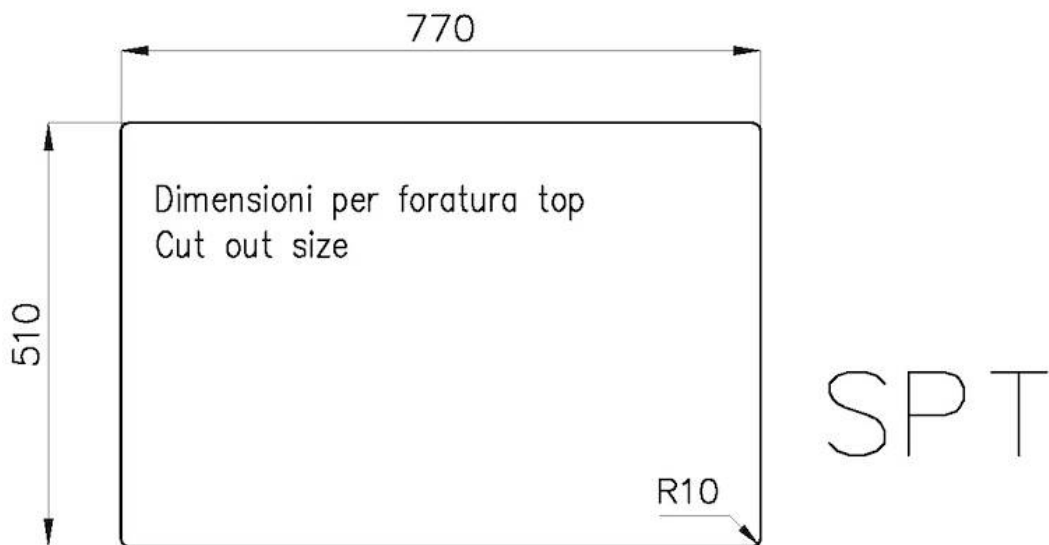
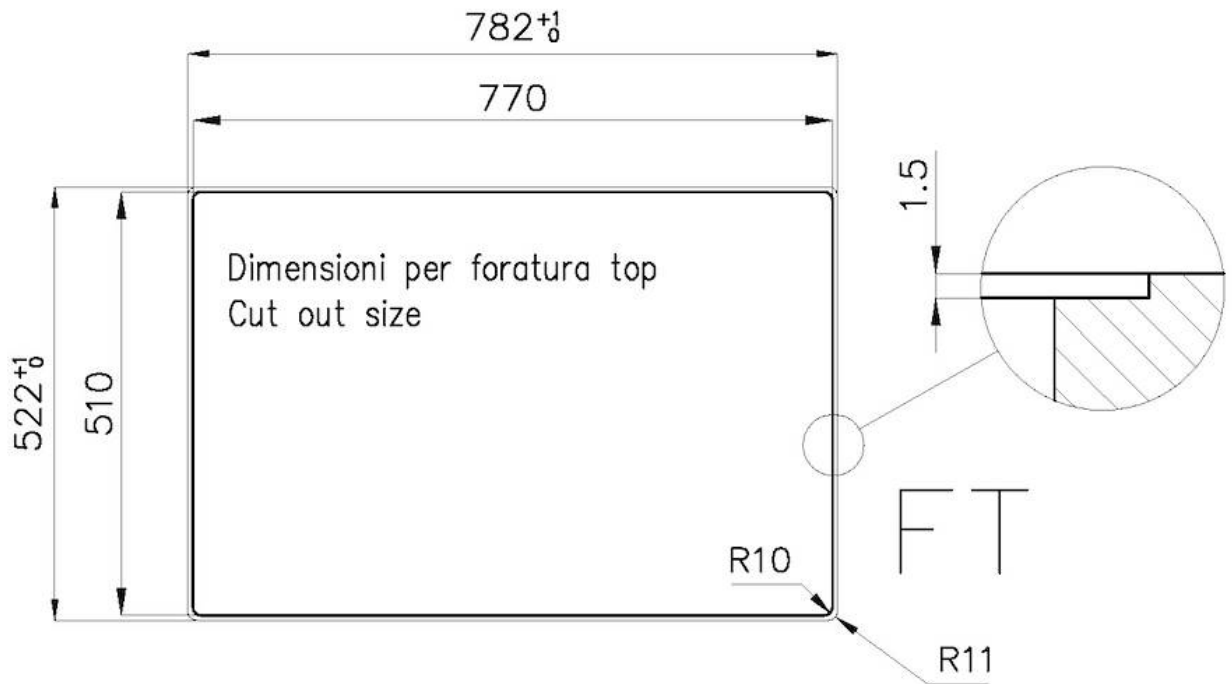

## GALLERY



## EQUIPMENT



**Black grid**  
8100 617

## OPTIONAL ACCESSORIES



**Glass chopping board**  
8631 300



**Graters kit with ring-holder and food collection tray**

8159 101

\* only in combination with the accessory  
8644 101



**HDPE Chopping board**  
8657 001



**HPDE Twin chopping board**  
8644 101



**Iroko-wood sliding chopping board with stainless steel colander**

8644 044



**Stainless steel perforated tray**  
8151 000

\* only in combination with the accessory  
8644 101



**Stainless steel perforated tray PVD  
Copper**

8151 008

\* only in combination with the accessory  
8644 101



**Stainless steel perforated tray PVD  
Gold**

8151 009

\* only in combination with the accessory  
8644 101



**Stainless steel perforated tray PVD  
Gun Metal**

8151 006

\* only in combination with the accessory  
8644 101



**Stainless steel plate rack**

8100 303

\* only in combination with the accessory  
8644 101

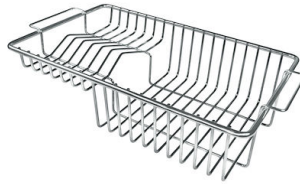

**Stainless steel plate rack**

8100 201



**White bowl**

8153 100

## RECOMMENDED PAIRINGS



**Cooker hob KE**

7602 032

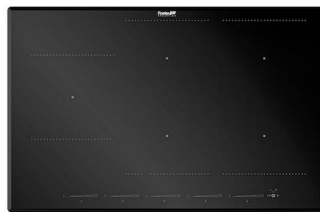

**Cooker hob KE Induction**

7386 646



**Mixer Tap Omega Plus**

8497 020

## OPTIONAL AUTOMATIC WASTE FITTINGS



**Automatic waste fitting - PM**  
8407 113



**Space automatic waste fitting - PA**  
8407 108



**Space automatic waste fitting - PE**  
8407 109



**Space Light automatic waste fitting  
- PL**  
8407 117



**Space Push automatic waste fitting  
- PP**  
8407 116